

Biology
Standard level
Paper 1

Wednesday 15 November 2017 (afternoon)

45 minutes

Instructions to candidates

- Do not open this examination paper until instructed to do so.
- Answer all the questions.
- For each question, choose the answer you consider to be the best and indicate your choice on the answer sheet provided.
- The maximum mark for this examination paper is **[30 marks]**.

The image of a *Paramecium* refers to question 1 and question 2.

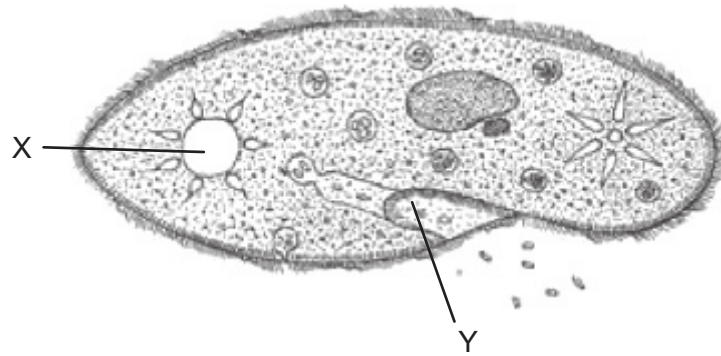

[Source: Adapted from www.biology-resources.com. Copyright 2004-2017 D G Mackean & Ian Mackean. All rights reserved.]

1. Which function is accomplished by structures X and Y in the *Paramecium*?

	X	Y
A.	excretion	digestion
B.	homeostasis	feeding
C.	movement	food storage
D.	respiration	DNA replication

2. What evidence from the image of *Paramecium* indicates whether the organism is a prokaryote or a eukaryote?

- A. Compartments in the cell indicate that it is a eukaryote.
- B. No nucleus indicates that the cell is a prokaryote.
- C. Lack of a cell wall indicates that the cell is a eukaryote.
- D. It is a unicellular organism, so it must be a prokaryote.

3. The salt concentration inside an animal cell is 1.8%. The salt concentration in the surrounding medium becomes 5%. What will be the likely response?

- A. The cell will gain water from the medium.
- B. The cell will lose salt to the medium.
- C. The cell will remain unchanged.
- D. The cell will shrink from loss of water.

6. Which molecule could be hydrolysed into amino acids?

A.

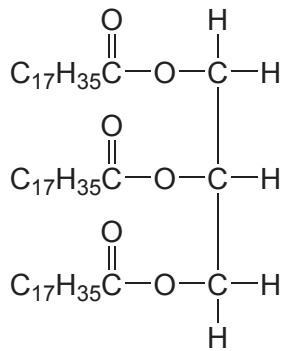

B.

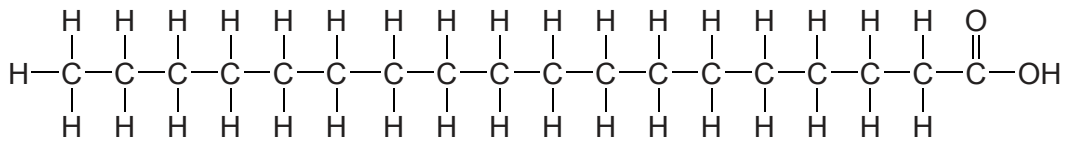

C.

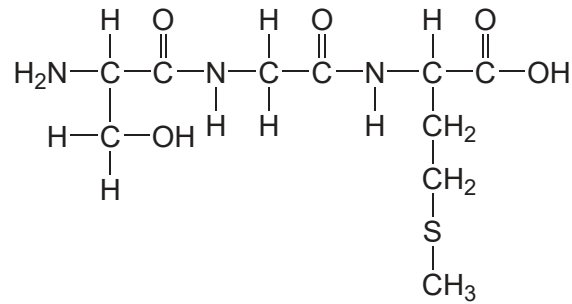

D.

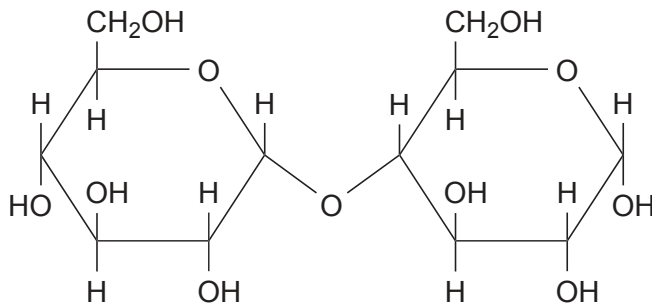

7. Which property of water accounts for its moderating effects on the Earth's atmosphere?

- A. Cohesive
- B. Thermal
- C. Transparency
- D. Adhesive

8. The Framingham heart study was an observational study that went on for 20 years. The following data were produced.

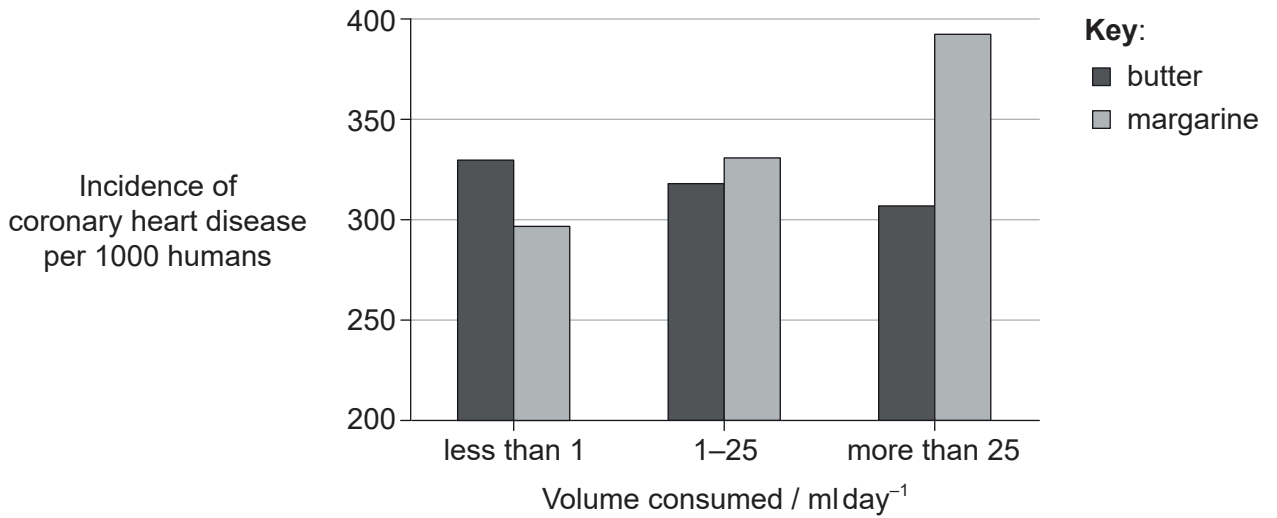

[Source: adapted from Gillman *et al.*, Margarine intake and subsequent coronary heart disease in men. *Epidemiology*, 1997 Mar; 8(2): 144-9]

Which conclusion can be drawn, based on these data?

- A. It is better to eat margarine than to eat butter.
- B. The more margarine consumed, the greater the incidence of coronary heart disease.
- C. Butter is a natural product whereas margarine is hydrogenated vegetable oil that leads to coronary heart disease.
- D. Margarine causes more heart related deaths than butter.

Turn over

9. Three flasks were prepared for an analysis of the activity of amylase. At time zero, each of the substances indicated in the diagrams was added.

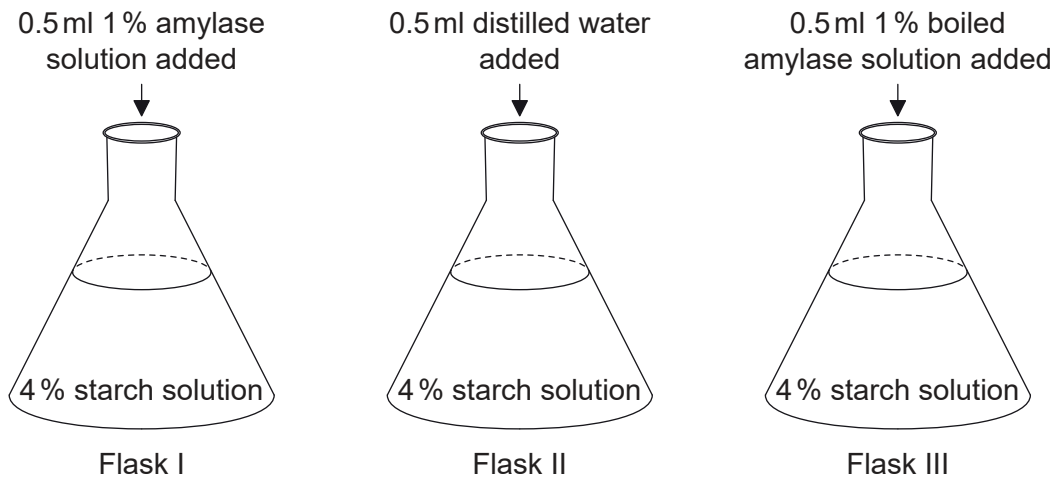

Which flask(s) could provide support for the hypothesis that heat denatures enzymes?

- A. Flasks I and II after 15 minutes
 - B. Flasks II and III after 15 minutes
 - C. Flasks I and III after 15 minutes
 - D. Flask III at time zero and again after 15 minutes
10. For which discovery about DNA do Watson and Crick receive credit?
- A. DNA is the molecule that genes are made of.
 - B. The amount of adenine equals the amount of thymine in an organism.
 - C. Phosphate-pentose bonding along the nucleotide backbone is covalent.
 - D. The shape of DNA is a double helix.

11. Which sequence of bases and amino acids could be produced by transcription and translation of the DNA molecule shown?

3' ATGAAATGCTTTTCGCGGG 5'
5' TACTTTACGAAAGCGCCC 3'

		2nd base in codon				
		U	C	A	G	
1st base in codon	U	Phe	Ser	Tyr	Cys	U
		Phe	Ser	Tyr	Cys	C
		Leu	Ser	STOP	STOP	A
		Leu	Ser	STOP	Trp	G
C	Leu	Pro	His	Arg	U	
	Leu	Pro	His	Arg	C	
	Leu	Pro	Gln	Arg	A	
	Leu	Pro	Gln	Arg	G	
A	Ile	Thr	Asn	Ser	U	
	Ile	Thr	Asn	Ser	C	
	Ile	Thr	Lys	Arg	A	
	Met	Thr	Lys	Arg	G	
G	Val	Ala	Asp	Gly	U	
	Val	Ala	Asp	Gly	C	
	Val	Ala	Glu	Gly	A	
	Val	Ala	Glu	Gly	G	

	Sequence of bases	Sequence of amino acids
A.	UAC-UUU-ACG-AAA-GCG-CCC	Leu-Lys-Cys-Phe-Arg-Gly
B.	GGG-CGC-UUU-CGU-AAA-CAU	Gly-Arg-Phe-Arg-Lys-His
C.	AUC-AAA-UGC-UUU-CGC-GGG	Met-Lys-Cys-Phe-Arg-Gly
D.	UAC-UUU-ACG-AAA-GCG-CCC	Tyr-Phe-Thr-Lys-Ala-Pro

12. Which process causes ADP to change to ATP?

- A. Hydrolysis
- B. Protein synthesis
- C. DNA replication
- D. Anaerobic cell respiration

Turn over

13. What occurs during meiosis but not mitosis?

- A. Spindles are formed from microtubules.
- B. Chromosome number is conserved.
- C. Homologous chromosomes pair up.
- D. Centromeres split.

14. Which diagram(s) represent(s) processes used in asexual reproduction?

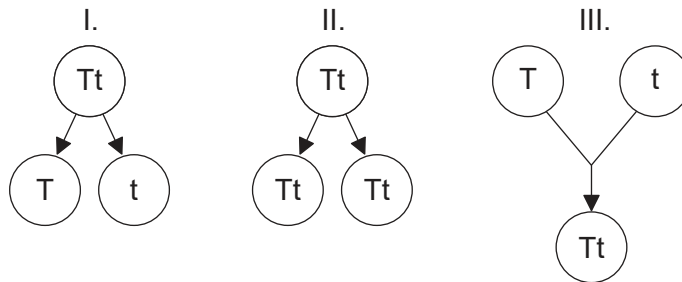

- A. I only
- B. I and II only
- C. II only
- D. I, II and III

15. *Hind*III is an endonuclease that recognizes the sequence AAGCTT, cutting between the two adenines.



Into how many DNA fragments would the strand shown be cut by *Hind*III?

- A. 2
- B. 3
- C. 4
- D. 5

16. An allele for lactase persistence allows humans to digest milk as adults. People who lack this allele are lactose intolerant in adulthood.

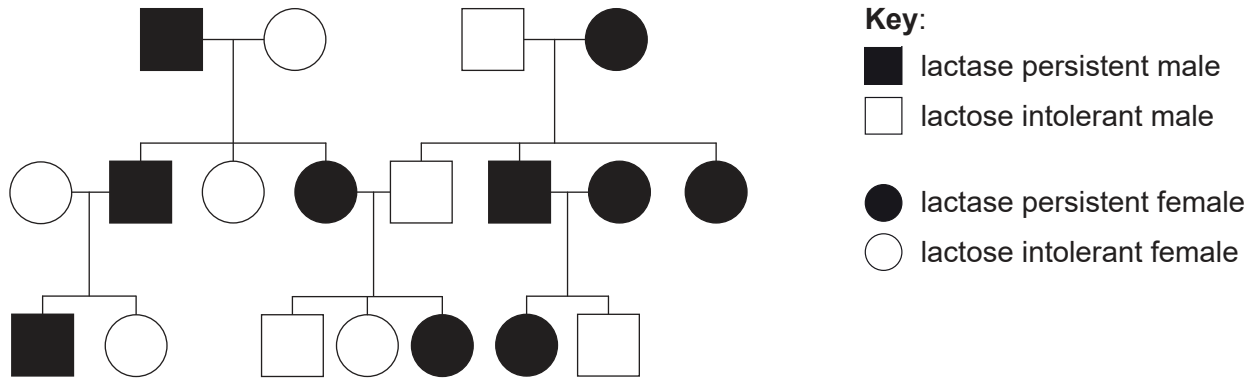

What is the pattern of inheritance?

- A. Lactase persistence is sex-linked recessive.
 - B. Lactase persistence is autosomal recessive.
 - C. Lactase persistence is sex-linked dominant.
 - D. Lactase persistence is autosomal dominant.
17. In an area of forest measuring 100 m by 100 m, samples were taken to estimate the number of silver maple (*Acer saccharinum*) trees in the forest. The number of trees counted in each of five areas of 400 m² was recorded.

	3			
			5	
4		5		
			8	

Approximately how many silver maple trees are in the 10 000m² area of forest?

- A. 5
- B. 25
- C. 125
- D. 625

Turn over

18. The diagram shows the carbon cycle.

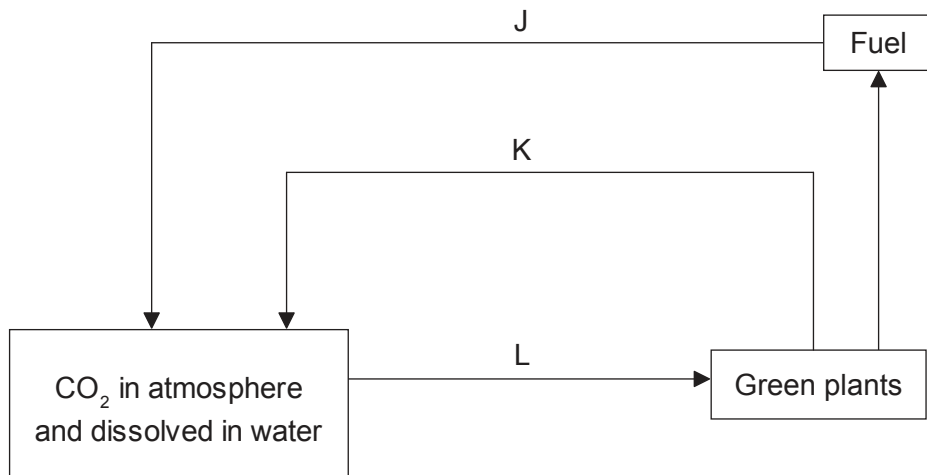

[Source: © International Baccalaureate Organization 2017]

Which two processes correspond to the labelled arrows?

- A. K is combustion and L is catabolism.
- B. J is anabolism and K is respiration.
- C. J is combustion and K is respiration.
- D. J is anabolism and L is catabolism.

19. An experiment was set up so that each test tube contained water at a pH of 6.3 and a pH indicator. Test tubes 1 and 2 also contained a common pond autotroph. Carbon dioxide dissolves in water and forms carbonic acid. After three days the four test tubes were found to have these results.

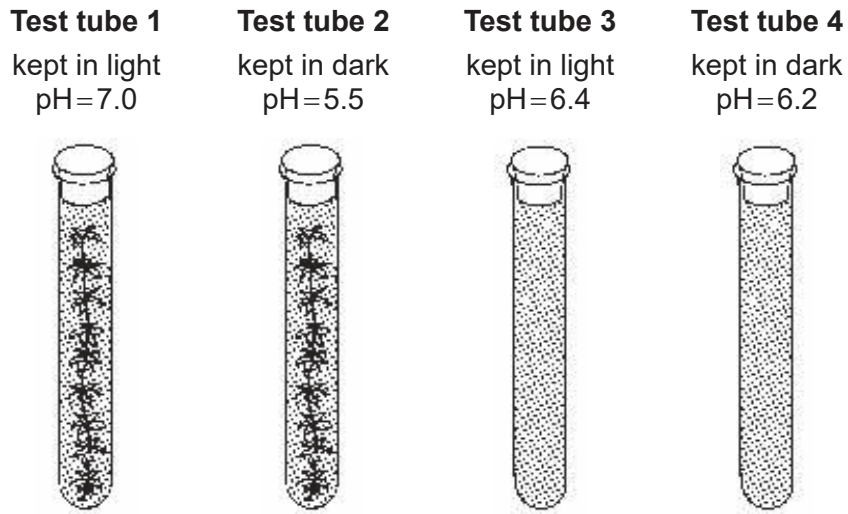

What conclusion can be drawn from test tube 1 and test tube 2?

	Test tube 1	Test tube 2
A.	photosynthesis has used CO ₂	respiration has produced CO ₂
B.	photosynthesis has made the water more acidic	respiration has made the water less acidic
C.	photosynthesis occurred but not respiration	respiration occurred but not photosynthesis
D.	no conclusion can be drawn, since pH in the controls has changed	

Turn over

20. Which of these structures is **not** homologous?

A.



B.



C.



D.

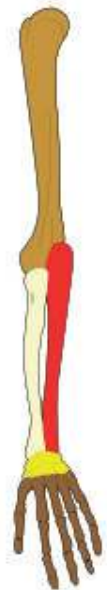

[Source: https://en.wikipedia.org/wiki/Comparative_anatomy#/media/File:Homology Vertebrates-en.svg and https://commons.wikimedia.org/wiki/File:Insect_leg_scheme.svg]

21. What causes variation within a population?

- A. Fertilization and change in the environment
- B. Fertilization and mutation
- C. Mutation and evolution
- D. Evolution and adaptive radiation

22. Which of the organisms A–D, identified by the key, represents a reptile?

- 1. fins, gills, 2-chamber heart fish
no fins, more than 2 chambers in heart go to 2
- 2. mucus on skin, gills and lungs A.
no gills, breathes with lungs go to 3
- 3. dry scales, lays eggs on land or live birth B.
constant body temperature, 4 limbs go to 4
- 4. lays eggs with hard shells C.
hair or fur, live birth D.

23. The table shows the number of differences between humans and other selected organisms for the protein cytochrome c oxidase. This protein, consisting of 104 amino acids, is located in the mitochondria and functions as an enzyme during cell respiration.

Organism pairs	Number of amino acid differences
Human – chimpanzee	0
Human – fruit fly	29
Human – horse	12
Human – pigeon	12
Human – rattlesnake	14
Human – rhesus monkey	1
Human – screwworm fly	27
Human – snapping turtle	15
Human – tuna fish	21

If the data were used to draw a cladogram, which chordates would be furthest apart from humans?

- A. Chimpanzee because it has zero differences
- B. Fruit fly because it has the most differences
- C. Tuna fish because it is the chordate with the most differences
- D. Horse because it is in the same class

Turn over

24. Dialysis membrane was set up to model digestion and absorption in the small intestine.

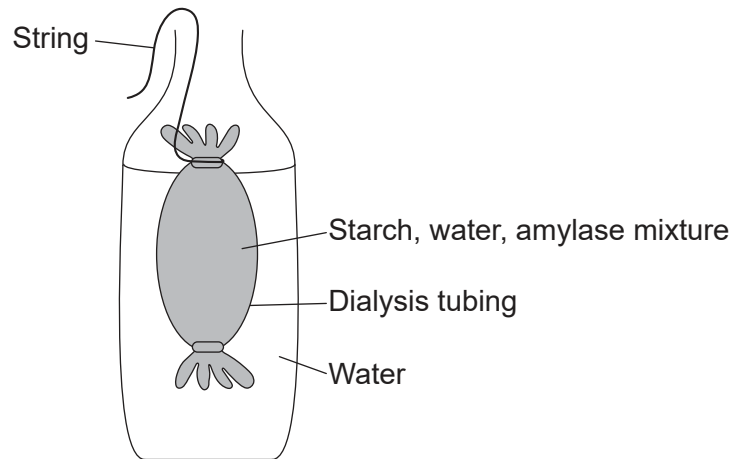

What is a limitation of this model?

- A. There can be no active transport.
- B. Maltose will pass through the membrane.
- C. Lipase should be present with protein.
- D. The membrane is not permeable to starch.

25. The diagram shows red blood cells and undifferentiated tissue cells.

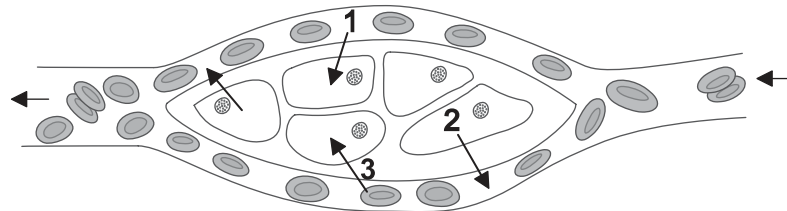

[Source: © International Baccalaureate Organization 2017]

Diffusion of oxygen from blood cells to tissue cells is represented by arrow 3 in the diagram. What molecules are shown diffusing by arrow 1 and arrow 2?

	Arrow 1	Arrow 2
A.	carbon dioxide	urea
B.	water	glucose
C.	glucose	carbon dioxide
D.	fatty acids	amino acids

26. What is a characteristic of antigens?
- A. They recognize foreign substances
 - B. They are produced in bone marrow
 - C. They cause disease in humans
 - D. They stimulate the production of antibodies

27. What can protect the body from blood loss?
- A. Antibodies
 - B. Fibrin
 - C. Histamines
 - D. Hemophilia

28. Which structure in the motor neuron is required for saltatory conduction?

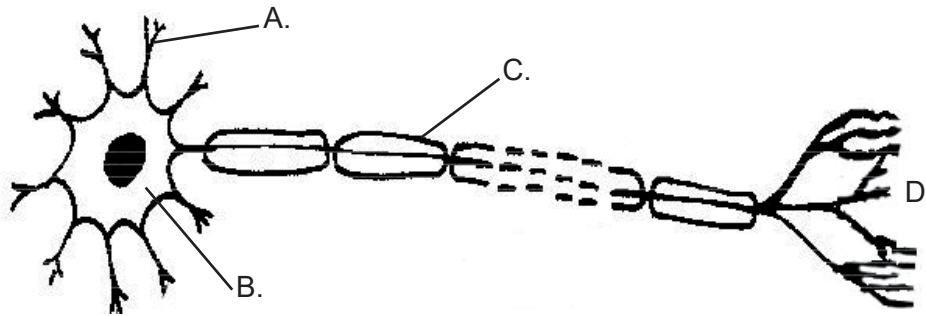

[Source: https://commons.wikimedia.org/wiki/File:Anatomy_and_physiology_of_animals_Motor_neuron.jpg]

29. Which hormone inhibits appetite?
- A. Epinephrine
 - B. Leptin
 - C. Thyroxin
 - D. Glucagon

30. What is the name and source of the hormone that regulates basal metabolic rate?

	Name	Source
A.	ADH	kidneys
B.	melatonin	pineal gland
C.	thyroxin	thyroid gland
D.	glucagon	pancreas
